

freedomRail®

THE TRULY ADJUSTABLE STORAGE SYSTEM

freedomRail offers the flexibility to change components, without any tools.

INSTALLATION IS AS EASY AS...



1 Install the Rail



2 Place Uprights and add Brackets



3 Add Components

freedomRail is the most innovative solution in home storage and organization.

It provides every benefit of a custom closet without the custom closet headaches of difficult installation and no adjustability or upgrading.



EASY TO INSTALL

Install the Rail to the wall.
All other components lock in place.



EASY TO ADJUST

Reposition a pantry shelf to fit a tall blender.
Adjust shelves to fit a growing child's clothes.



EASY TO UPGRADE

Add components to customize and upgrade your storage at any time.



Watch Now. Learn How.

organizedliving.com/installation/freedomRail



Contact Us.

Phone: 1-888-674-5484 8 am-5 pm EST Mon-Fri.
Email: customerservice@organizedliving.com
organizedliving.com/installation

Organized Living

REQUIRED TOOLS

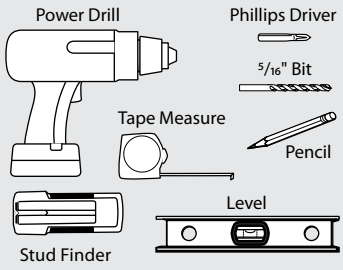

CUTTING TOOLS*

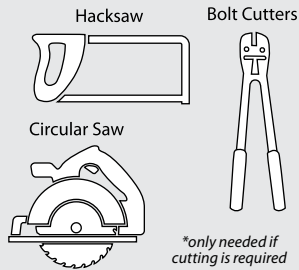

For complete installation information including videos to watch and learn visit: organizedliving.com/installation/freedomRail

RAIL (R)

The Rail is the primary support component of the freedomRail system. Getting the Rail mounted level and secure is the most important step. The standard height for the Rail is 84" from the floor. *If a design includes 90" Uprights, install the Rail at 96" from the floor.*

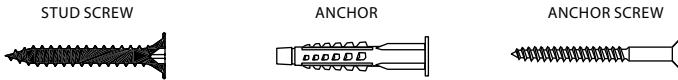

1. Measure 84" from the floor and draw horizontal line.
2. Use a stud finder to lightly mark the beginning and end of the first 2 studs closest to the height mark.
3. Position the Rail (R) on the wall at the correct height. At the first stud, drive a black Stud Screw through the Rail in the center of the diamond hole.
4. While leveling the Rail, drive a black Stud Screw through the Rail into the second stud.
5. Use the stud finder to mark the diamond holes over the remaining studs. Drive a black Stud Screw into each of the remaining studs where marked.
6. Use a 5/16" drill bit and drill a hole for the Anchor in the first and last hole of the Rail. Tap in plastic Anchor and then drive Anchor Screw into each end hole. **IMPORTANT:** Allow screw to turn 6-8 rotations after it's flush with the Rail so the Anchor tightens into a ball behind the drywall.
7. Continue to drill and insert Anchor and Anchor Screw in the center hole between every stud.

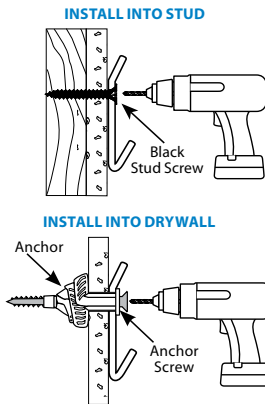

See diagram below for proper Stud Screw and Anchor and Anchor Screw placement.

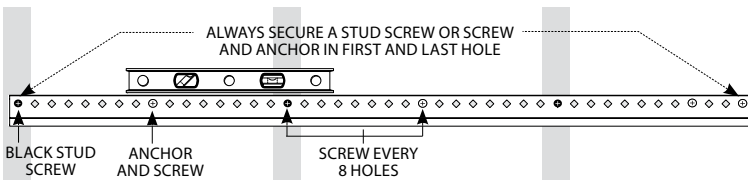

Note: If your freedomRail design includes 2 Rails, repeat these steps while holding the second Rail flush with the first Rail and level.

8. Review your design to determine if the second Rail is required. Most likely, your second Rail will need to be cut. If so, measure and cut the Rail accordingly using a hacksaw.
9. Place Cover on the Rail by aligning the Cover slot and Rail edge. Press firmly downwards. Start at one end and slide your hands the entire length of the Cover and back.

UPRIGHTS, BRACKETS, AND ROD CLIPS

Uprights hang from the Rail providing a track to install components.

UPRIGHTS (U) AND BRACKETS (B)

1. Place your Uprights at appropriate spacing intervals on the Rail according to your design.
2. Insert Brackets into Uprights at desired shelf heights.

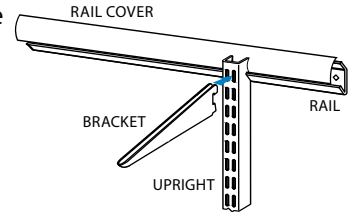

ROD CLIPS

1. Rod Clips are placed into Brackets prior to installing shelves.
2. If there is hanging space in your design, insert Rod Clips into Bracket and pull down until you hear a click and the clips are securely in place.

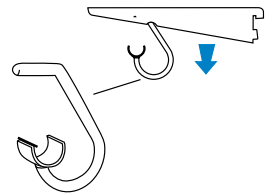

OBOXES® AND REVEAL ACCESSORIES

OBoxes, or Organization Boxes, are storage units that are packaged separately with all necessary hardware for assembly and installation. Reveal accessories need no assembly.

1. Assemble the OBox using the instructions inside the packaging.
2. Insert OBox or Reveal Accessory Brackets into the inside slot of each Upright. You may need to shift the Uprights by tapping them into the correct position.
3. If you are installing a stack of OBoxes or Reveal Accessories, install the bottom one first.

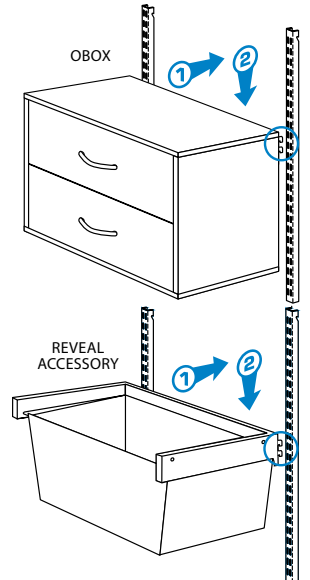

- If placing any accessory next to an OBox, an additional Upright is required.
- If placing 2 Reveal Accessories side-by-side, the accessories can share a single Upright.

Tip: For OBoxes with drawers or baskets, attach the OBox to the Upright before putting in the drawers or baskets. Installing OBoxes this way is easier because they're lighter without the drawers or baskets.



For the complete library of OBox assembly videos, visit: organizedliving.com/installation/freedomRail

WOOD SHELVES (S)

Wood Shelving comes with Shelf-Locs to position and secure the Shelves to the Brackets.

1. Place 2 Shelf-Locs into each Bracket facing up. Remove paper tabs.
2. Place Shelf onto Bracket in desired position. Press to adhere to Shelf-Locs.

Shelves may be cut to fit exact measurements using a circular saw. Draw a level line from the front to the back of the Shelf. Be sure to mark the cut-line so that the raw/cut edge will be installed against a wall.

Tip: To allow for complete adjustability, shelves and clothes rods may extend up to 5" past the Upright for 2' shelves or up to 9" for shelves longer than 2'.

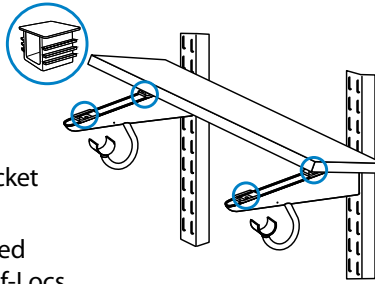

2' SHELF

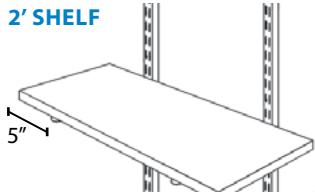

OVER 2' SHELF

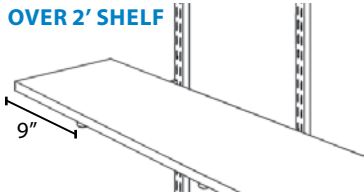

WOOD SHOE SHELVES (SS)

Wood Shoe Shelves require a Metal or Wood Shoe Fence to securely hold shoes in place at an angle.

METAL SHOE FENCE

1. Use a rubber mallet to tap the Metal Shoe Fence into the Pre-Drilled Wood Shoe Shelf. Tap one side fully into the Shelf while keeping the opposite side off the Shelf.
2. Next, position the opposite end of the metal shoe fence in the remaining hole. Use a mallet to tap the fence securely in place.
3. Use a slanted Wood Shoe Bracket to install the Wood Shoe Shelf. Secure to Brackets with Shelf-Locs.

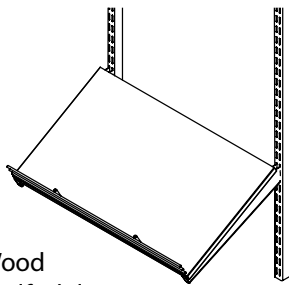

WOOD SHOE FENCE

1. Hold Wood Shoe Fence onto the Wood Shelf and mount with 1½" wood screw.
2. Use a slanted Wood Shoe Bracket to install the Wood Shoe Shelf. Secure to Brackets with Shelf-Locs.

VENTILATED SHELVES (S)

Ventilated Shelving snaps into the Brackets.

1. Lay Shelf onto Brackets with center Shelf rod positioned over center bracket notch.
2. Push down on center Shelf rod. Then lift the front edge and slide the Shelf back.
3. Apply End Caps to edges.

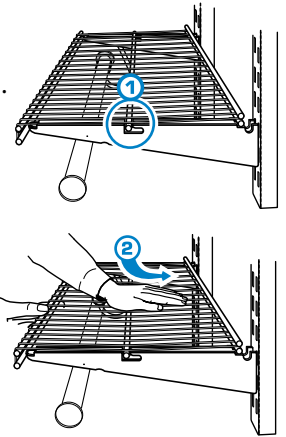

Shelves may be cut to fit exact measurements using a pipe cutter.

CLOTHES ROD (CR) AND ROD STOPS

1. After all shelving is in place, measure the area where the hanging will be from left to right and subtract ¼".
2. Use a hacksaw to cut through the Clothes Rod.
3. Insert Rod Stops at the ends of the Clothes Rod and spin the flange until it is halfway up threaded shaft.
4. Push Rod Stop into Clothes Rod; then twist the Rod Stop until it tightens.
5. Align the Clothes Rod on the Rod Clips then pull down and twist until securely fastened.

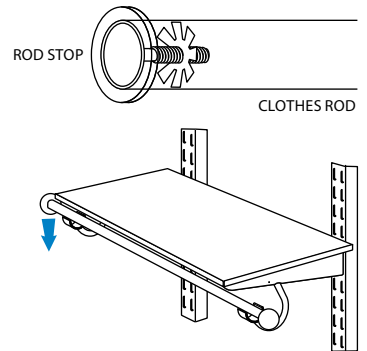

UPRIGHT COVERS

Upright Covers are an added enhancement to the freedomRail system to provide an aesthetically pleasing way to conceal Uprights.

1. After the freedomRail system has been installed, determine the length to cut with your tape measure and mark the inside of the cover.
2. Cut the Upright Cover along the marked cut line with heavy-duty scissors.
3. Simply push the cover on the Upright for the perfect finishing touch.

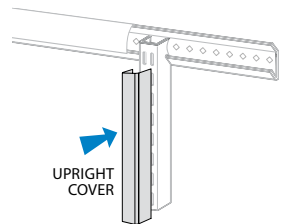

Tip: If you do not have a tape measure, align the cover next to the exposed Upright and use a pencil to mark a cut line.

Thank You!

freedomRail adjusts to your needs!
Now that you have completed assembly, any of the components can be adjusted to accommodate your needs or new components added at any time for a truly customized closet!



For more help, visit our complete library of installation videos, visit:
organizedliving.com/installation/freedomRail